

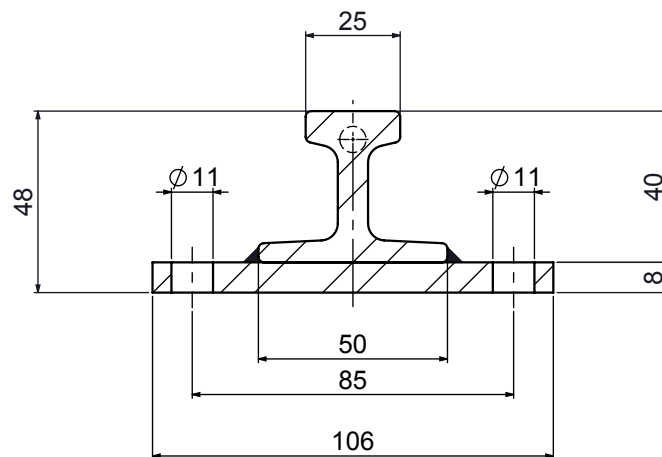

SEZIONE A-A

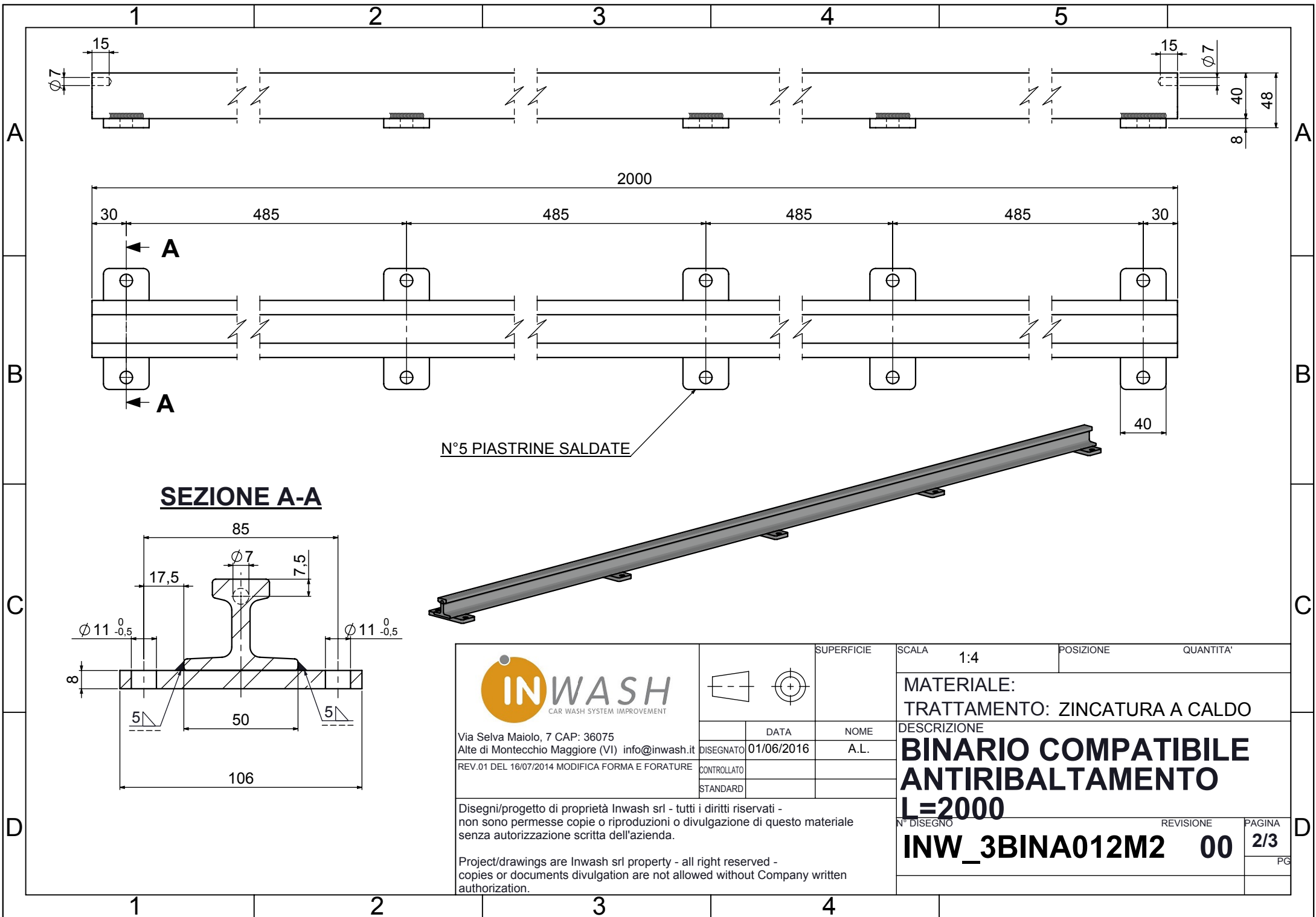



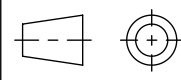

SEZIONE A-A

N°5 PIASTRINE SALDATE

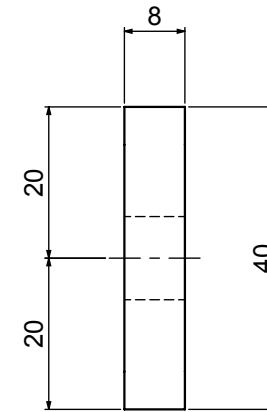
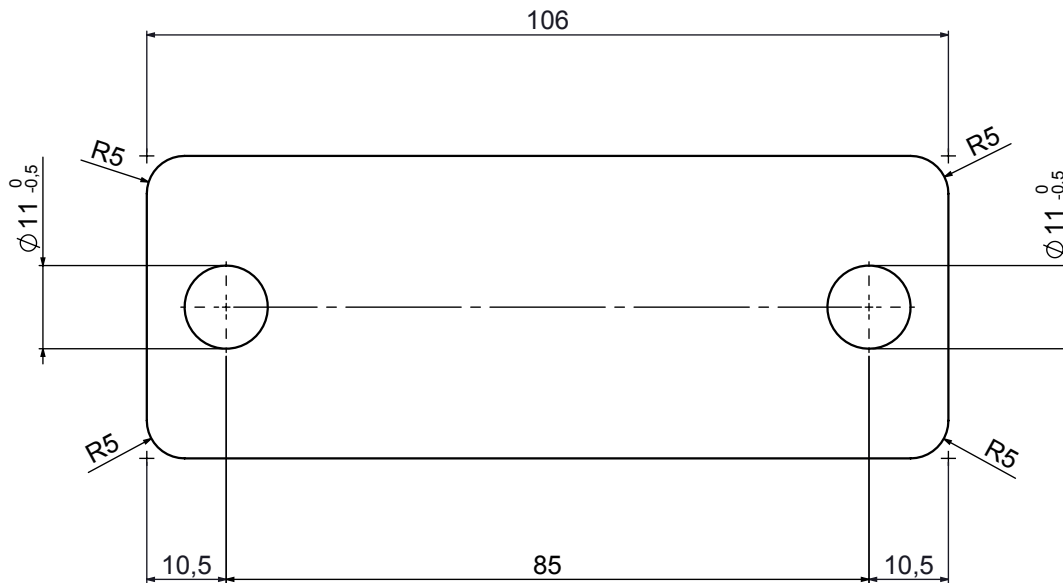
 <p>Via Selva Maiolo, 7 CAP: 36075 Alte di Montecchio Maggiore (VI) info@inwash.it REV.01 DEL 16/07/2014 MODIFICA FORMA E FORATURE</p>		SUPERFICIE	SCALA	1:4	POSIZIONE	QUANTITA'
		DATA 01/06/2016 NOME A.L.	DESCRIZIONE MATERIALE: TRATTAMENTO: ZINCATURA A CALDO BINARIO COMPATIBILE ANTIRIBALTAMENTO L=2000			
Disegni/progetto di proprietà Inwash srl - tutti i diritti riservati - non sono permesse copie o riproduzioni o divulgazione di questo materiale senza autorizzazione scritta dell'azienda. Project/drawings are Inwash srl property - all right reserved - copies or documents divulgation are not allowed without Company written authorization.	DISEGNATO CONTROLLATO STANDARD	N° DISEGNO INW_3BINA012M2	REVISIONE 00	PAGINA 2/3 PG		

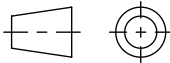

 <p>Via Selva Maiolo, 7 CAP: 36075 Alte di Montecchio Maggiore (VI) info@inwash.it</p> <p>REV.01 DEL 16/07/2014 MODIFICA FORMA E FORATURE</p> <p>Disegni/progetto di proprietà Inwash srl - tutti i diritti riservati - non sono permesse copie o riproduzioni o divulgazione di questo materiale senza autorizzazione scritta dell'azienda.</p> <p>Project/drawings are Inwash srl property - all right reserved - copies or documents divulgation are not allowed without Company written authorization.</p>		SUPERFICIE	SCALA	1:4	POSIZIONE	QUANTITA'								
		<table border="1"> <tr> <td>DATA</td> <td>NOME</td> </tr> <tr> <td>01/06/2016</td> <td>A.L.</td> </tr> <tr> <td>DISEGNATO</td> <td></td> </tr> <tr> <td>CONTROLLATO</td> <td></td> </tr> <tr> <td>STANDARD</td> <td></td> </tr> </table>	DATA	NOME	01/06/2016	A.L.	DISEGNATO		CONTROLLATO		STANDARD		<p>MATERIALE: Fe 360 B</p> <p>TRATTAMENTO:</p>	
DATA	NOME													
01/06/2016	A.L.													
DISEGNATO														
CONTROLLATO														
STANDARD														
<p>PIASTRA 105X40 SP.8MM PER BINARIO AE COMPATIBILE</p>		N° DISEGNO	REVISIONE	PAGINA										
		INW_PIASTRA-AE	00	3/3										
				PG										